



i500 inverters

0.25 ... 132 kW

Lenze makes many things easy for you.

With our motivated and committed approach, we work together with you to create the best possible solution and set your ideas in motion - whether you are looking to optimize an existing machine or develop a new one. We always strive to make things easy and seek perfection therein. This is anchored in our thinking, in our services and in every detail of our products. It's as easy as that!

On principle: Always perfect: the new i500

The i500 is ideal for numerous applications:
travelling drives, conveyor drives, shaper drives, pumps and fans, tool drives, hoist drives and winding drives.

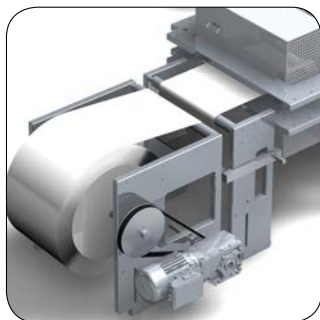
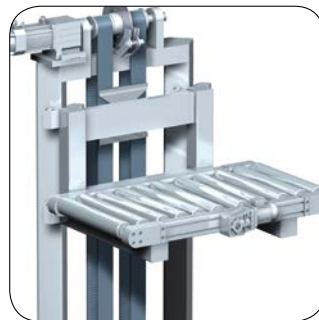
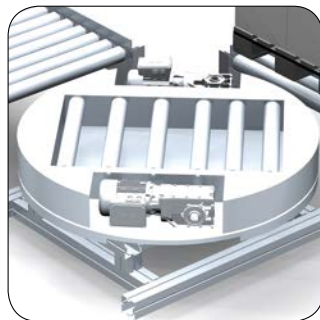

Less means more!

Focused on the essentials: the new i500

i500 is the new inverter series - a streamlined design, scalable functionality and exceptional user-friendliness.

Less unnecessary elements

- High scalability in terms of the mains voltage range, rated power and modular structure
- Diagnostics via keypad, USB or WLAN

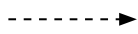

More cost savings

- Optimised solution for individual customer requirements
- Flexibility

Smaller size

- Compact size:
Up to 11 kW just 130mm deep and up to 2.2 kW just 60mm wide
- Side-by-side installation: can be mounted adjacent to each other

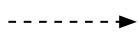

More space in the control cabinet

- Provides solutions in limited spaces
- Smaller control cabinets reduce costs

Less engineering expenditure

- Intuitively logical structure of parameters
- Easy controller integration
- Supports all current networks

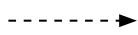

More time for the essentials

- Saves time in engineering
- Reduction in potential error sources

Less installation expense

- Keyhole mounting
- Pluggable terminals up to 2.2 kW
- Out of the box operability. Simply connect, start, go!
- Plug-in memory module

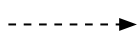

More productivity

- Saves time during installation
- Fewer faults in use
- Lower costs in the event of a service

Less energy consumption

- Fewer inverter losses thanks to the use of cutting-edge technologies
- Energy-efficient

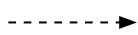

More sustainability

- Best efficiency values, lowest energy costs
- Future-proof thanks to DIN EN 50598

Less downtime

- Robust single board design
- Entire device produced by Lenze

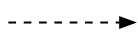



Greater reliability

- Lower quality assurance costs in manufacture
- Reduces operational guarantee costs

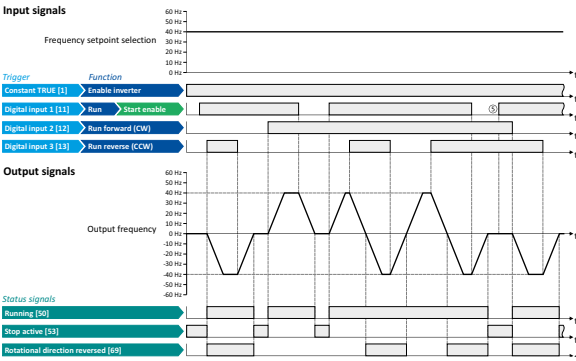

Functionality

i500 provides a high-quality frequency inverter that already conforms to future standard in accordance with the EN 50598-2 efficiency classes (IE). Overall, this provides a reliable and future-proof drive for a wide range of machine applications.

Adjustable motor controls for three-phase AC motors	
	<ul style="list-style-type: none"> • V/f characteristic control linear/square-law (VFC plus) • Sensorless vector control (SLV) • Energy saving function (VFC-ECO) • Servo control (SC-ASM) with feedback • Sensorless vector control for synchronous motors (up to 22 kW)
Motor functions	
	<ul style="list-style-type: none"> • Flying restart circuit • Slip compensation • Energy saving function (VFC-Eco) • DC braking • Oscillation damping • Skip frequencies • Automatic identification of the motor data • Braking energy management • Holding brake control • Voltage add-function • Rational Energy Ride Through (backup operation in case of mains failure) • Speed feedback (HTL encoder) • Brake resistor control (brake chopper integrated) • DC-bus connection (400 V devices)
Application functions	
	<ul style="list-style-type: none"> • Process controller (PID) • Process controller - sleep mode and rinse function • Freely assignable favorite menu • Parameter change-over • S-shaped ramps for smooth acceleration • Motor potentiometer • Flexible I/O configuration • Access protection • Automatic restart • OEM parameter set • Sequence control

Monitoring

off	off	No supply voltage
1 Hz	Safe torque off (STO) active	Safe torque off (STO) active, warning active
2 Hz	Inverter disabled	Inverter disabled, no DC-bus voltage
	Inverter disabled, warning active	Inverter disabled, error available
	Inverter enabled and motor running	Inverter enabled and motor running, warning pending
	Inverter enabled, quick stop as response to a fault active	
Error message	Cause and remedy (W = warning, T = trouble, F = fault)	
.2382/.2383	Ixt fault/Ixt warning	
.3210/.3211	Overvoltage DC-bus/warning overvoltage DC-bus	
.3220/.3221	DC-bus voltage too low for switch-on	
.3222	DC-bus voltage too low for switch-on	
.4310	Motor overtemperature error	
.6280	Trigger/functions incorrectly connected. In flexible mode, the controller release or Run/Stop must be allocated to an I/O. Do not use start forward/backward and run forward/backward at the same time.	
.FF37	Automatic start disabled	

- Short circuit
- Earth fault
- Device overload monitoring (i*t)
- Motor overload monitoring (i²*t)
- Mains phase failure
- Stalling protection
- Motor current limit
- Maximum torque
- Ultimate motor current
- Motor speed monitoring
- Load loss detection
- Motor temperature monitoring (PTC and thermal contact)

Diagnostics



- Error history buffer
- Logbook
- LED status displays
- Keypad language selection German, English
- PC tool (EASY Starter)
- Smartphone app (iOS and Android)



App Store



Google Play

Safety functions (optional)



- STO (Safe torque off) with PL “e” and SIL 3





Network (optional)



- CANopen
- Modbus RTU
- ModBus TCP
- IO-Link
- EtherCAT
- EtherNet/IP
- PROFIBUS
- PROFINET
- POWERLINK

Scalability

Easily scaled, the right i500 can be customised to suit the application. Here, “scaled” refers to two optimised products: the i510 as the basic design with predefined modes and the high-capacity modular i550 for a variety of applications. Which is the right one for you? See the following table:

	i510	i550	
Type of construction and ordering option	Monolithic construction	Modular type of construction	
Power range	0.25 kW ... 15 kW	0.25 kW ... 132 kW	
Scope	<ul style="list-style-type: none"> Memory module IT network suitability Integrated RFI filter (apart from i510-Cxxx/230-2) Can be directly connected Relay (type C) 	<ul style="list-style-type: none"> Memory module IT network suitability Integrated RFI filter (apart from i550-Cxxx/120-1, i550-Cxxx/230-2, i550-Cxxx/230-3) Can be directly connected Relay (type C) Brake chopper DC-bus operation is possible Incremental HTL encoder up to 100 kHz Temperature monitoring Functional safety: STO 	
I/O extension	<ul style="list-style-type: none"> Spring terminal, fixed terminals Basic I/O <ul style="list-style-type: none"> - 5 digital inputs - 1 digital output - 2 analog inputs - 1 analog output 	<ul style="list-style-type: none"> Plug-in spring terminal External 24-V supply Choice of negative or positive logic (PNP/NPN) Standard I/O <ul style="list-style-type: none"> - 5 digital inputs, 1 digital output - 2 analog inputs, 1 analog output or Application I/O <ul style="list-style-type: none"> - 7 digital inputs, 2 digital outputs - 2 analog inputs, 2 analog outputs 	
Fieldbus network – optional	<ul style="list-style-type: none"> CANopen Modbus RTU 	<ul style="list-style-type: none"> CANopen Modbus RTU Modbus TCP IO-Link EtherCAT EtherNet/IP PROFIBUS PROFINET POWERLINK 	
Motor controls	<ul style="list-style-type: none"> V/f characteristic control (VFC open loop, linear, quadratic or FVC Eco) Sensorless vector control (SLVC) Sensorless control (SL PSM) 	<ul style="list-style-type: none"> V/f characteristic control (VFC open loop, linear, quadratic or FVC Eco) V/f characteristic control (VFC closed loop) with feedback Sensorless vector control (SLVC) Sensorless control (SL PSM) Servo control (SC-ASM) with feedback (up to 22 kW) 	
i510		i550	
 <p>Two versions: with Basic I/O with Basic I/O and CANopen / Modbus RTU</p>	<div style="display: flex; justify-content: space-between;"> <div style="text-align: center;"> <p>Control unit Standard-I/O</p>  <p>PROFIBUS PROFINET EtherNet/IP EtherCAT Modbus TCP POWERLINK</p> </div> <div style="text-align: center;"> <p>Power unit</p>  <p>Without network</p> </div> <div style="text-align: center;"> <p>Control unit Application-I/O</p>  <p>Without network</p> </div> </div> <div style="text-align: center; margin-top: 10px;">  <p>Safety module</p> </div>		

The scalable inverter is completed by an accessory kit. Simply select all the necessary components oriented to your application.

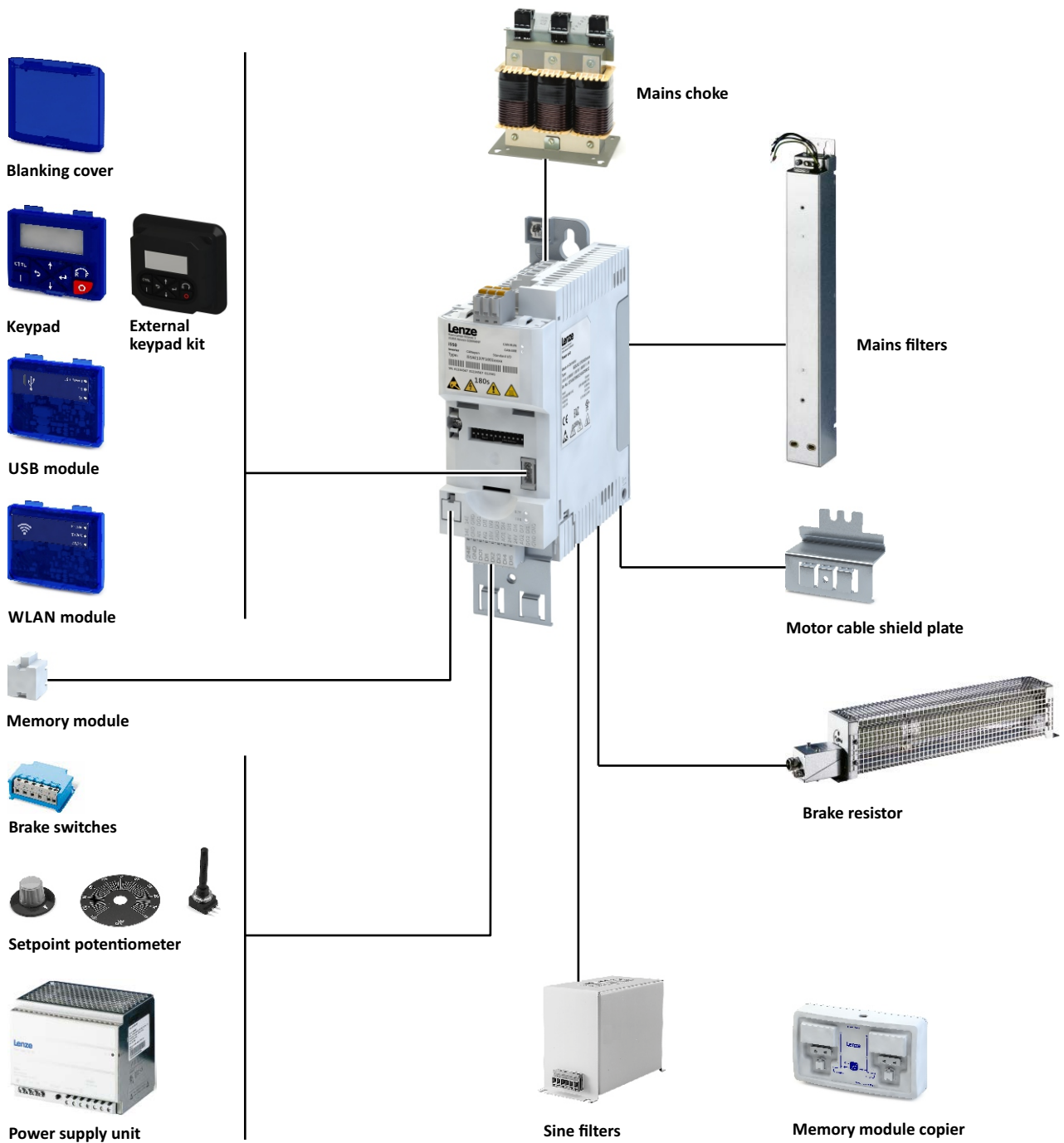

Technical data

Inverter i510; connection to 230-V mains

Conformities	CE	2014/35/EU, 2014/30/EU
	EAC	TR TC 004/2011, TP TC 020/2011
	RoHS 2	2011/65/EU
Approvals	cUL _{us}	UL 61800-5-1, CSA 22.2 No. 274
Energy efficiency	Class IE2	EN 50598-2
Protection type	IP20	EN 60529 (except in wire range of terminals)
		NEMA 250 (type 1 protection against accidental contact only)
	Open type	Only in UL-approved systems
Power systems	TT, TN	Voltage to earth: max. 300 V
	IT	Apply the measures described for IT systems!
Mains switching		3 x within one minute possible
Operation with residual current circuit breaker		Up to 2.2 kW 30 mA
Cable length for EMC	Category C2	20 m (≤0.37 kW max. 15 m)
	Category C3	≥ 35 m (≤0.37 kW max. 15 m)
Switching frequencies		2, 4, 8, 16 kHz, The rated output currents listed below apply at 45 °C and switching frequencies of 2 and 4 kHz, and at 40 °C and switching frequencies of 8 and 16 kHz
Ambient temperature		55 °C (derating of 2.5 %/°C above 45 °C)
Max. output frequency		0 Hz ... 599 Hz
Overload capacity		200 % for 3s; 150 % for 60 s

	Rated power	Mains voltage range	Rated output current	Weight	Dimensions (h x w x d)
	[kW]	[V]	[A]	[kg]	[mm]
1-phase inverter with integrated RFI filter					
i510-C0.25/230-1	0.25	1/N/PE AC 170 V ... 264 V 45 Hz ... 65 Hz	1.7	0.75	155 x 60 x 130
i510-C0.37/230-1	0.37		2.4	0.75	155 x 60 x 130
i510-C0.55/230-1	0.55		3.2	0.95	180 x 60 x 130
i510-C0.75/230-1	0.75		4.2	0.95	180 x 60 x 130
i510-C1.1/230-1	1.1		6	1.35	250 x 60 x 130
i510-C1.5/230-1	1.5		7	1.35	250 x 60 x 130
i510-C2.2/230-1	2.2		9.6	1.35	250 x 60 x 130
1/3-phase inverter without integrated RFI filter					
i510-C0.25/230-2	0.25	1/N/PE AC or 3/PE AC 170 V ... 264 V 45 Hz ... 65 Hz	1.7	0.75	155 x 60 x 130
i510-C0.37/230-2	0.37		2.4	0.75	155 x 60 x 130
i510-C0.55/230-2	0.55		3.2	0.95	180 x 60 x 130
i510-C0.75/230-2	0.75		4.2	0.95	180 x 60 x 130
i510-C1.1/230-2	1.1		6	1.35	250 x 60 x 130
i510-C1.5/230-2	1.5		7	1.35	250 x 60 x 130
i510-C2.2/230-2	2.2		9.6	1.35	250 x 60 x 130
3-phase inverter without integrated RFI filter					
i510-C4.0/230-3	4	3/PE AC 170 V ... 264 V 45 Hz ... 65 Hz	16.5	2.1	250 x 90 x 130
i510-C5.5/230-3	5.5		23	2.1	250 x 90 x 130

Inverter i510; connection to 400-V mains

Conformities	CE	2014/35/EU, 2014/30/EU
	EAC	TR TC 004/2011, TP TC 020/2011
	RoHS 2	2011/65/EU
Approvals	cUL _{us}	UL 61800-5-1, CSA 22.2 No. 274
Energy efficiency	Class IE2	EN 50598-2
Protection type	IP20	EN 60529 (except in wire range of terminals) NEMA 250 (type 1 protection against accidental contact only)
	Open type	Only in UL-approved systems
Power systems	TT, TN	Voltage to earth: max. 300 V
	IT	Apply the measures described for IT systems!
Mains switching		3 x within one minute possible
Operation with residual current circuit breaker		Up to 2.2 kW 30 mA
Cable length for EMC	Category C2	20 m (≤0.37 kW max. 15 m)
	Category C3	35 m (≤0.37 kW max. 15 m)
Switching frequencies		2, 4, 8, 16 kHz, The rated output currents listed below apply at 45 °C and switching frequencies of 2 and 4 kHz, and at 40 °C and switching frequencies of 8 and 16 kHz
Ambient temperature		55 °C (derating of 2.5 %/°C above 45 °C)
Max. output frequency		0 Hz ... 599 Hz
Overload capacity		200 % for 3s; 150 % for 60 s

	Rated power	Mains voltage range	Rated output current	Weight	Dimensions (h x w x d)
	[kW]	[V]	[A]	[kg]	[mm]
3-phase inverter with integrated RFI filter					
i510-C0.37/400-3	0.37	3/PE AC 340 V ... 528 V 45 Hz ... 65 Hz	1.3	0.75	155 x 60 x 130
i510-C0.55/400-3	0.55		1.8	0.95	180 x 60 x 130
i510-C0.75/400-3	0.75		2.4	0.95	180 x 60 x 130
i510-C1.1/400-3	1.1		3.2	1.35	250 x 60 x 130
i510-C1.5/400-3	1.5		3.9	1.35	250 x 60 x 130
i510-C2.2/400-3	2.2		5.6	1.35	250 x 60 x 130
i510-C3.0/400-3	3		7.3	1.35	250 x 60 x 130
i510-C4.0/400-3	4		9.5	1.35	250 x 60 x 130
i510-C5.5/400-3	5.5		13	2.3	250 x 90 x 130
i510-C7.5/400-3	7.5		16.5	3.7	276 x 120 x 130
i510-C11/400-3	11		23.5	3.7	276 x 120 x 130
3-phase mains connection 400 V - Light duty; with integrated RFI filter					
i510-C3.0/400-3	4	3/PE AC 340 V ... 528 V 45 Hz ... 65 Hz	8.8	1.35	250 x 60 x 130
i510-C4.0/400-3	5.5		11.9	1.35	250 x 60 x 130
i510-C5.5/400-3	7.5		15.6	2.3	250 x 90 x 130
i510-C7.5/400-3	11		23	3.7	276 x 120 x 130
i510-C11/400-3	15		28.2	3.7	276 x 120 x 130

i510-C3.0/400-3 and i510-C4.0/400-3 of the generation "A" are 90 mm wide.
As stated, the devices of the generation "B" with a width of 60 mm are 33% smaller.

Inverter i550; connection to 120 V mains and 230 V mains

Conformities	CE	2014/35/EU, 2014/30/EU
	EAC	TR TC 004/2011, TP TC 020/2011
	RoHS 2	2011/65/EU
Approvals	cUL _{us}	UL 61800-5-1, CSA 22.2 No. 274
Energy efficiency	Class IE2	EN 50598-2
Protection type	IP20	EN 60529 (except in wire range of terminals) NEMA 250 (type 1 protection against accidental contact only)
	Open type	Only in UL-approved systems
Power systems	TT, TN	Voltage to earth: max. 300 V
	IT	Apply the measures described for IT systems!
Mains switching		3 x within one minute possible
Operation with residual current circuit breaker		up to 2.2 kW 30 mA, above this 300 mA
Cable length for EMC	Category C2	20 m (≤0.37 kW max. 15 m)
	Category C3	≥ 35 m (≤0.37 kW max. 15 m)
Switching frequencies		2, 4, 8, 16 kHz, The rated output currents listed below apply at 45 °C and switching frequencies of 2 and 4 kHz, and at 40 °C and switching frequencies of 8 and 16 kHz
Max. ambient temperature		55 °C (derating of 2.5 %/ °C above 45 °C)
Max. output frequency		0 Hz ... 599 Hz
Overload capacity		200 % for 3s; 150 % for 60 s

	Rated power	Mains voltage range	Rated output current	Weight	Dimensions (h x w x d)
	[kW]	[V]	[A]	[kg]	[mm]
1-phase mains connection 120 V; without integrated RFI filter					
i550-C0.25/120-1	0.25	1/N/PE AC 90 V ... 132 V 45 Hz ... 65 Hz	1.7	1	180 x 60 x 130
i550-C0.37/120-1	0.37		2.4	1	180 x 60 x 130
i550-C0.75/120-1	0.75		4.2	1.35	250 x 60 x 130
i550-C1.1/120-1	1.1		6	1.35	250 x 60 x 130
1-phase mains connection 230/240 V; with integrated RFI filter					
i550-C0.25/230-1	0.25	1/N/PE AC 170 V ... 264 V 45 Hz ... 65 Hz	1.7	0.8	155 x 60 x 130
i550-C0.37/230-1	0.37		2.4	0.8	155 x 60 x 130
i550-C0.55/230-1	0.55		3.2	1	180 x 60 x 130
i550-C0.75/230-1	0.75		4.2	1	180 x 60 x 130
i550-C1.1/230-1	1.1		6	1.35	250 x 60 x 130
i550-C1.5/230-1	1.5		7	1.35	250 x 60 x 130
i550-C2.2/230-1	2.2		9.6	1.35	250 x 60 x 130
1-phase mains connection 230/240 V; without integrated RFI filter					
i550-C0.25/230-2	0.25	1/N/PE A 170 V ... 264 V 45 Hz ... 65 Hz	1.7	0.8	155 x 60 x 130
i550-C0.37/230-2	0.37		2.4	0.8	155 x 60 x 130
i550-C0.55/230-2	0.55		3.2	1	180 x 60 x 130
i550-C0.75/230-2	0.75		4.2	1	180 x 60 x 130
i550-C1.1/230-2	1.1		6	1.35	250 x 60 x 130
i550-C1.5/230-2	1.5		7	1.35	250 x 60 x 130
i550-C2.2/230-2	2.2		9.6	1.35	250 x 60 x 130
3-phase mains connection 230/240 V; without integrated RFI filter					
i550-C0.25/230-2	0.25	3/PE AC 170 V ... 264 V 45 Hz ... 65 Hz	1.7	0.8	155 x 60 x 130
i550-C0.37/230-2	0.37		2.4	0.8	155 x 60 x 130
i550-C0.55/230-2	0.55		3.2	1	180 x 60 x 130
i550-C0.75/230-2	0.75		4.2	1	180 x 60 x 130
i550-C1.1/230-2	1.1		6	1.35	250 x 60 x 130
i550-C1.5/230-2	1.5		7	1.35	250 x 60 x 130
i550-C2.2/230-2	2.2		9.6	1.35	250 x 60 x 130
i550-C4.0/230-3	4		16.5	2.1	250 x 90 x 130
i550-C5.5/230-3	5.5		23	2.1	250 x 90 x 130

Inverter i550; connection to 400 V mains

Certain i550 400 V inverters can be operated with two load characteristics.

Heavy Duty: For requirements with high overload behaviour.

Light Duty: For requirements with low-level overload behaviour.

Conformities	CE	2014/35/EU, 2014/30/EU
	EAC	TR TC 004/2011, TP TC 020/2011
	RoHS 2	2011/65/EU
Approvals	cUL _{us}	UL 61800-5-1, CSA 22.2 No. 274
Energy efficiency	Class IE2	EN 50598-2
Protection type	IP20	EN 60529 (except in wire range of terminals)
	Open type	NEMA 250 (type 1 protection against accidental contact only) Only in UL-approved systems
Power systems	TT, TN	Voltage to earth: max. 300 V
	IT	Apply the measures described for IT systems!
Mains switching		3 x within one minute possible
Operation with residual current circuit breaker		Up to 2.2 kW 30 mA
Cable length for EMC	Category C2	20 m (≤0.37 kW max. 15 m)
	Category C3	35 m (≤0.37 kW max. 15 m)
Switching frequencies		2, 4, 8, 16 kHz, The rated output currents listed below apply at 45 °C and switching frequencies of 2 and 4 kHz, and at 40 °C and switching frequencies of 8 and 16 kHz
Ambient temperature		55 °C (derating of 2.5 %/°C above 45 °C)
Max. output frequency		0 Hz ... 599 Hz
Overload capacity		200 % for 3s; Heavy Duty: 150 % for 60s; Light Duty: 120 % for 60 s

	Rated power	Mains voltage range	Rated output current	Weight	Dimensions (h x w x d)
	[kW]	[V]	[A]	[kg]	[mm]
3-phase mains connection 400 V – heavy duty; with integrated RFI filter					
i550-C0.37/400-3	0.37	3/PE AC 340 V ... 528 V 45 Hz ... 65 Hz	1.3	0.8	155 x 60 x 130
i550-C0.55/400-3	0.55		1.8	1	180 x 60 x 130
i550-C0.75/400-3	0.75		2.4	1	180 x 60 x 130
i550-C1.1/400-3	1.1		3.2	1.35	250 x 60 x 130
i550-C1.5/400-3	1.5		3.9	1.35	250 x 60 x 130
i550-C2.2/400-3	2.2		5.6	1.35	250 x 60 x 130
i550-C3.0/400-3	3		7.3	1.35	250 x 60 x 130
i550-C4.0/400-3	4		9.5	1.35	250 x 60 x 130
i550-C5.5/400-3	5.5		13	2.3	250 x 90 x 130
i550-C7.5/400-3	7.5		16.5	3.7	276 x 120 x 130
i550-C11/400-3	11		23.5	3.7	276 x 120 x 130
i550-C15/400-3	15		32	10.3	347 x 204.5 x 222
i550-C18/400-3	18.5		40	10.3	347 x 204.5 x 222
i550-C22/400-3	22		47	10.3	347 x 204.5 x 222
i550-C30/400-3	30		61	17.2	450 x 250 x 230
i550-C37/400-3	37		76	17.2	450 x 250 x 230
i550-C45/400-3	45		89	17.2	450 x 250 x 230
i550-C55/400-3	55		110	24	536 x 250 x 265
i550-C75/400-3	75		150	24	536 x 250 x 265
i550-C90/400-3	90		180	35.6	685 x 258 x 304
i550-C110/400-3	110	212	35.6	685 x 258 x 304	
3-phase mains connection 400 V - Light duty; with integrated RFI filter					
i550-C3.0/400-3	4	3/PE AC 340 V ... 528 V 45 Hz ... 65 Hz	8.8	1.35	250 x 60 x 130
i550-C4.0/400-3	5.5		11.9	1.35	250 x 60 x 130
i550-C5.5/400-3	7.5		15.6	2.3	250 x 90 x 130
i550-C7.5/400-3	11		23	3.7	276 x 120 x 130
i550-C11/400-3	15		28.2	3.7	276 x 120 x 130
i550-C15/400-3	18.5		38.4	10.3	347 x 204.5 x 222
i550-C18/400-3	22		48	10.3	347 x 204.5 x 222
i550-C22/400-3	30		56.4	10.3	347 x 204.5 x 222
i550-C30/400-3	37		73.2	17.2	450 x 250 x 230
i550-C37/400-3	45		91.2	17.2	450 x 250 x 230
i550-C45/400-3	55		107	17.2	450 x 250 x 230
i550-C55/400-3	75		132	24	536 x 250 x 265
i550-C75/400-3	90		180	24	536 x 250 x 265
i550-C90/400-3	110		216	35.6	685 x 258 x 304
i550-C110/400-3	132		254	35.6	685 x 258 x 304

i550-C3.0/400-3 and i550-C4.0/400-3 of the generation "A" are 90 mm wide.

As stated, the devices of the generation "B" with a width of 60 mm are 33% smaller.

Order codes i500

i510 or i550:

Delivery as complete inverter

If the same inverter is always inserted into the machine, the inverter can be ordered “out of the box”. i5x0 is the designation for both products; these products can be ordered in the power range of up to 11 kW.

Ordering information for complete devices

Example for inverter i550-C2.2/400-3:

Inverter	Order code				
<ul style="list-style-type: none"> 3-phase mains connection 400 V Power 2.2 kW Safety function STO Standard I/O with CANopen 	i55AE222F1	A	V1	0	002S

Inverter	Order code			
i5x0-C0.25/120-1	i5xAE125A1			
i5x0-C0.37/120-1	i5xAE137A1			
i5x0-C0.75/120-1	i5xAE175A1			
i5x0-C1.1/120-1	i5xAE211A1			
i5x0-C0.25/230-1	i5xAE125B1			
i5x0-C0.37/230-1	i5xAE137B1			
i5x0-C0.55/230-1	i5xAE155B1			
i5x0-C0.75/230-1	i5xAE175B1			
i5x0-C1.1/230-1	i5xAE211B1			
i5x0-C1.5/230-1	i5xAE215B1			
i5x0-C2.2/230-1	i5xAE222B1			
i5x0-C0.25/230-2	i5xAE125D1			
i5x0-C0.37/230-2	i5xAE137D1			
i5x0-C0.55/230-2	i5xAE155D1			
i5x0-C0.75/230-2	i5xAE175D1			
i5x0-C1.1/230-2	i5xAE211D1			
i5x0-C1.5/230-2	i5xAE215D1			
i5x0-C2.2/230-2	i5xAE222D1			
i5x0-C4.0/230-3	i5xAE240C1			
i5x0-C5.5/230-3	i5xAE255C1			
i5x0-C0.37/400-3	i5xAE137F1			
i5x0-C0.55/400-3	i5xAE155F1			
i5x0-C0.75/400-3	i5xAE175F1			
i5x0-C1.1/400-3	i5xAE211F1			
i5x0-C1.5/400-3	i5xAE215F1			
i5x0-C2.2/400-3	i5xAE222F1			
i5x0-C3.0/400-3	i5xAE230F1			
i5x0-C4.0/400-3	i5xAE240F1			
i5x0-C5.5/400-3	i5xAE255F1			
i5x0-C7.5/400-3	i5xAE275F1			
i5x0-C11/400-3	i5xAE311F1			
i550-C15/400-3	i55AE315F1			
i550-C18.5/400-3	i55AE318F1			
i550-C22/400-3	i55AE322F1			
i550-C30/400-3	i55AE330F1			
i550-C37/400-3	i55AE337F1			
i550-C45/400-3	i55AE345F1			
i550-C55/400-3	i55AE355F1			
i550-C75/400-3	i55AE375F1			
i550-C90/400-3	i55AE390F1			
i550-C110/400-3	i55AE411F1			
Safety engineering				
Without safety function				0
Safety function STO				A
Control code				
Type				
Global type, mains frequency 50 Hz				0
USA type, mains frequency 60 Hz				1
Compact device types i510				
Basic I/O				000S
Basic I/O with CANopen/Modbus				001S
Mounted control unit in the case of the i550				
Standard I/O without network				000S
Application I/O without network				001S
Standard I/O with CANopen				002S
Standard I/O with Modbus RTU				003S
Standard I/O with IO-Link				016S
Standard I/O with PROFIBUS				004S
Standard I/O with EtherCAT				00KS
Standard I/O with PROFINET				00LS
Standard I/O with EtherNet/IP				00MS
Standard I/O with Modbus TCP				00WS
Standard I/O with POWERLINK				012S

i550:
delivery as components

If different product versions are required in the machine, the various components can be ordered individually. Depending on the application, the components can be plugged together easily without any further tools.

Ordering information for components

Example for inverter i550-C2.2/400-3:

Components	Order code
<ul style="list-style-type: none"> 3-phase mains connection 400 V Power 2.2 kW 	I5DAE222F10V10000S
Safety function STO	I5MASAV000000S
Standard I/O with CANopen	I5CA5C02000VA0000S





Power Unit inverter	Order code
i550-C0.25/120-1	i5DAE125A10V00000S
i550-C0.37/120-1	i5DAE137A10V00000S
i550-C0.75/120-1	i5DAE175A10V00000S
i550-C1.1/120-1	i5DAE211A10V00000S
i550-C0.25/230-1	i5DAE125B10V10000S
i550-C0.37/230-1	i5DAE137B10V10000S
i550-C0.55/230-1	i5DAE155B10V10000S
i550-C0.75/230-1	i5DAE175B10V10000S
i550-C1.1/230-1	i5DAE211B10V10000S
i550-C1.5/230-1	i5DAE215B10V10000S
i550-C2.2/230-1	i5DAE222B10V10000S
i550-C0.25/230-2	i5DAE125D10V00000S
i550-C0.37/230-2	i5DAE137D10V00000S
i550-C0.55/230-2	i5DAE155D10V00000S
i550-C0.75/230-2	i5DAE175D10V00000S
i550-C1.1/230-2	i5DAE211D10V00000S
i550-C1.5/230-2	i5DAE215D10V00000S
i550-C2.2/230-2	i5DAE222D10V00000S
i550-C4.0/230-3	i5DAE240C10V00000S
i550-C5.5/230-3	i5DAE255C10V00000S
i550-C0.37/400-3	i5DAE137F10V10000S
i550-C0.55/400-3	i5DAE155F10V10000S
i550-C0.75/400-3	i5DAE175F10V10000S
i550-C1.1/400-3	i5DAE211F10V10000S
i550-C1.5/400-3	i5DAE215F10V10000S
i550-C2.2/400-3	i5DAE222F10V10000S
i550-C3.0/400-3	i5DAE230F10V10000S
i550-C4.0/400-3	i5DAE240F10V10000S
i550-C5.5/400-3	i5DAE255F10V10000S
i550-C7.5/400-3	i5DAE275F10V10000S
i550-C11/400-3	i5DAE311F10V10000S
i550-C15/400-3	i5DAE315F10V10000S
i550-C18.5/400-3	i5DAE318F10V10000S
i550-C22/400-3	i5DAE322F10V10000S
i550-C30/400-3	i5DAE330F10V10000S
i550-C37/400-3	i5DAE337F10V10000S
i550-C45/400-3	i5DAE345F10V10000S
i550-C55/400-3	i5DAE355F10V10000S
i550-C75/400-3	i5DAE375F10V10000S
i550-C90/400-3	i5DAE390F10V10000S
i550-C110/400-3	i5DAE411F10V10000S

Control unit	Order code	
	50 Hz	60 Hz
Standard I/O without network	I5CA5002000VA0000S	I5CA5002000VA1000S
Application I/O without network	I5CA5003000VA0000S	I5CA5003000VA1000S
Standard I/O with CANopen	I5CA5C02000VA0000S	I5CA5C02000VA1000S
Standard I/O with Modbus RTU	I5CA5W02000VA0000S	I5CA5W02000VA1000S
Standard I/O with Modbus TCP	I5CA5V02000VA0000S	I5CA5V02000VA1000S
Standard I/O with IO-Link	I5CA5K02000VA0000S	I5CA5K02000VA1000S
Standard I/O with PROFIBUS	I5CA5P02000VA0000S	I5CA5P02000VA1000S
Standard I/O with EtherCAT	I5CA5T02000VA0000S	I5CA5T02000VA1000S
Standard I/O with PROFINET	I5CA5R02000VA0000S	I5CA5R02000VA1000S
Standard I/O with EtherNet/IP	I5CA5G02000VA0000S	I5CA5G02000VA1000S
Standard I/O with POWERLINK	I5CA5N02000VA0000S	I5CA5N02000VA1000S

Product extensions

Diagnostics and operation of the i510 and i550

For diagnostics and parameterisation, the keypad, the Lenze SMART Keypad app (iOS and Android) or the EASY Starter can be used.

Inverter	External keypad	Keypad	WLAN	USB
				
i550-Cxxx/120-1 i5x0-Cxxx/230-1 i5x0-Cxxx/230-2 i550-Cxxx/230-3 i5x0-Cxxx/400-3	I5MADR000000S	I5MADK000000S	I5MADW000000S	I5MADU000000S
	3 m cable			3 m cable
	I5MADR000001S			EWL0085/S
	5 m cable			5 m cable
	I5MADR000002S			EWL0086/S

Functional safety i550

The safety function STO can also be ordered at a later date and retrofitted.

Inverter	Safety function STO (Safe torque off)
	
i550-Cxxx/120-1 i550-Cxxx/230-1 i550-Cxxx/230-2 i550-Cxxx/230-3 i550-Cxxx/400-3	I5MASAV000000S

Shield plate for i510 and i550

Accessories to safeguard the EMC if the motor shield is not installed on an earthing bus-bar in the control cabinet.

From 15 kW onwards, the shield plate is included with the inverter on delivery.

Inverter	Shield mounting kit	
Inverter i510 and i550 0.25 ... 2.2 kW	EZAMBHXM014/S	1x motor shield plate 2 x fixing clips
	EZAMBHXM014/M	5 x motor shield plates 10 x fixing clips
Inverter i510 and i550 3.0 kW ... 5.5 kW	IEZAMBHXM015/S	1 x motor shield plate 2 x fixing clips 1 x clamps (cable diameter 4 mm ... 15 mm)
	IEZAMBHXM015/M	5 x motor shield plates 5 x fixing clips 5 x clamps (cable diameter 4 mm ... 15 mm)
Inverter i510 and i550 7.5 kW ... 11 kW	EZAMBHXM016/S	1 x motor shield plate 1 x fixing clip 1 x clamp (cable diameter 10 mm ... 20 mm)
	EZAMBHXM016/M	5 x motor shield plates 5 x fixing clips 5 x clamps (cable diameter 10 mm ... 20 mm)
Inverter i550 15 kW ... 45 kW	EZAMBHXM004/M	5 x clamps (cable diameter 15 mm ... 28 mm)
	EZAMBHXM005/M	5 x clamps (cable diameter 20 mm ... 37 mm)
Inverter i550 55 kW ... 75 kW	EZAMBHXM005/M	5 x clamps (cable diameter 20 mm ... 37 mm)

Accessories

Accessories for i510; connection to 230-V mains

Inverter	Rated power [kW]	Mains voltage range [V]	Brake resistor	
				
			Order codes	Dimensions (h x w x d) [mm]
i510-C0.25/230-1	0.25	1/N/PE AC 170 V ... 264 V 45 Hz ... 65 Hz	–	–
i510-C0.37/230-1	0.37		–	–
i510-C0.55/230-1	0.55		–	–
i510-C0.75/230-1	0.75		–	–
i510-C1.1/230-1	1.1		–	–
i510-C1.5/230-1	1.5		–	–
i510-C2.2/230-1	2.2		–	–
i510-C0.25/230-2	0.25	1/N/PE AC or 3/PE AC 170 V ... 264 V 45 Hz ... 65 Hz	–	–
i510-C0.37/230-2	0.37		–	–
i510-C0.55/230-2	0.55		–	–
i510-C0.75/230-2	0.75		–	–
i510-C1.1/230-2	1.1		–	–
i510-C1.5/230-2	1.5		–	–
i510-C2.2/230-2	2.2		–	–
i510-C4.0/230-3	4	3/PE AC 170 V ... 264 V 45 Hz ... 65 Hz	–	–
i510-C5.5/230-3	5.5		–	–
Heavy Duty				
i510-C0.37/400-3	0.37	3/PE AC 340 V ... 528 V 45 Hz ... 65 Hz	–	–
i510-C0.55/400-3	0.55		–	–
i510-C0.75/400-3	0.75		–	–
i510-C1.1/400-3	1.1		–	–
i510-C1.5/400-3	1.5		–	–
i510-C2.2/400-3	2.2		–	–
i510-C3.0/400-3	3.0		–	–
i510-C4.0/400-3	4.0		–	–
i510-C5.5/400-3	5.5		–	–
i510-C7.5/400-3	7.5		–	–
i510-C11/400-3	11	–	–	
Light Duty				
i510-C3.0/400-3	4	3/PE AC 340 V ... 528 V 45 Hz ... 65 Hz	–	–
i510-C4.0/400-3	5.5		–	–
i510-C5.5/400-3	7.5		–	–
i510-C7.5/400-3	11		–	–
i510-C11/400-3	15		–	–

There are also additional accessory components available for the i510 inverter. You can find the complete range in the configuration document for the i510.

	Mains choke		RFI filter			
			Short Distance		Long Distance	
	<ul style="list-style-type: none"> Optional Reduction of the effective mains current Fewer current harmonics 		<ul style="list-style-type: none"> C1 up to 25 m (≤ 0.37 kW up to max. 15 m) C2 up to 50 m (≤ 0.37 kW up to max. 15 m) Operation with 30 mA residual-current circuit breaker 		<ul style="list-style-type: none"> C1 up to 50 m (≤ 0.37 kW up to max. 15 m) C2 up to 100 m (≤ 0.37 kW up to max. 15 m); ≤ 2.2 kW up to max. 50 m) Operation with 300 mA residual-current circuit breaker 	
	Order codes	Dimensions (h x w x d)	Order codes	Dimensions (h x w x d)	Order codes	Dimensions (h x w x d)
		[mm]		[mm]		[mm]
	ELN1-0900H005	75 x 66 x 82	IOFAE175B100S0000S	276 x 60 x 50	IOFAE175B100D0000S	276 x 60 x 50
	ELN1-0900H005	75 x 66 x 82	IOFAE175B100S0000S	276 x 60 x 50	IOFAE175B100D0000S	276 x 60 x 50
	ELN1-0500H009	75 x 66 x 82	IOFAE175B100S0000S	276 x 60 x 50	IOFAE175B100D0000S	276 x 60 x 50
	ELN1-0500H009	75 x 66 x 82	IOFAE175B100S0000S	276 x 60 x 50	IOFAE175B100D0000S	276 x 60 x 50
	ELN1-0250H018	96 x 96 x 90	IOFAE222B100S0000S	346 x 60 x 50	IOFAE222B100D0000S	346 x 60 x 50
	ELN1-0250H018	96 x 96 x 90	IOFAE222B100S0000S	346 x 60 x 50	IOFAE222B100D0000S	346 x 60 x 50
	ELN1-0250H018	96 x 96 x 90	IOFAE222B100S0000S	346 x 60 x 50	IOFAE222B100D0000S	346 x 60 x 50
	EZAELN3002B153	56 x 77 x 100	–	–	–	–
	EZAELN3004B742	60 x 95 x 115	–	–	–	–
	EZAELN3004B742	60 x 95 x 115	–	–	–	–
	EZAELN3006B492	69 x 95 x 117	–	–	–	–
	EZAELN3006B492	69 x 95 x 117	–	–	–	–
	EZAELN3008B372	85 x 120 x 140	–	–	–	–
	EZAELN3010B292	85 x 120 x 140	–	–	–	–
	EZAELN3016B18	95 x 120 x 140	–	–	–	–
	EZAELN3025B12	110 x 155 x 170	–	–	–	–
	EZAELN3002B203	56 x 77 x 100	IOFAE175F100S0000S	276 x 60 x 50	IOFAE175F100D0000S	276 x 60 x 50
	EZAELN3002B153	56 x 77 x 100	IOFAE175F100S0000S	276 x 60 x 50	IOFAE175F100D0000S	276 x 60 x 50
	EZAELN3004B742	60 x 95 x 114	IOFAE175F100S0000S	276 x 60 x 50	IOFAE175F100D0000S	276 x 60 x 50
	EZAELN3004B742	60 x 95 x 114	IOFAE222F100S0000S	346 x 60 x 50	IOFAE222F100D0000S	346 x 60 x 50
	EZAELN3004B742	60 x 95 x 114	IOFAE222F100S0000S	346 x 60 x 50	IOFAE222F100D0000S	346 x 60 x 50
	EZAELN3006B492	69 x 95 x 120	IOFAE222F100S0000S	346 x 60 x 50	IOFAE222F100D0000S	346 x 60 x 50
	EZAELN3008B372	85 x 120 x 140	IOFAE255F100S0001S	346 x 90 x 60	IOFAE240F100D0000S	346 x 60 x 50
	EZAELN3010B292	85 x 120 x 140	IOFAE255F100S0001S	346 x 90 x 60	IOFAE240F100D0000S	346 x 60 x 50
	EZAELN3016B182	95 x 120 x 140	IOFAE255F100S0001S	346 x 90 x 60	IOFAE255F100D0001S	346 x 90 x 50
	EZAELN3016B182	95 x 120 x 140	IOFAE311F100S0000S	371 x 120 x 60	IOFAE311F100D0000S	371 x 120 x 60
	EZAELN3025B122	110 x 155 x 170	IOFAE311F100S0000S	371 x 120 x 60	IOFAE311F100D0000S	371 x 120 x 60
	EZAELN3010B292	85 x 120 x 140	IOFAE255F100S0001S	346 x 90 x 50	IOFAE240F100D0000S	346 x 60 x 50
	EZAELN3016B182	95 x 120 x 140	IOFAE255F100S0001S	346 x 90 x 50	IOFAE255F100D0001S	346 x 90 x 60
	EZAELN3016B182	95 x 120 x 140	IOFAE255F100S0001S	346 x 90 x 50	IOFAE255F100D0001S	346 x 90 x 60
	EZAELN3025B122	110 x 155 x 170	IOFAE311F100S0000S	371 x 120 x 60	IOFAE311F100D0000S	371 x 120 x 60
	EZAELN3030B981	110 x 155 x 170	IOFAE311F100S0000S	371 x 120 x 60	IOFAE311F100D0000S	371 x 120 x 60

Accessories

Accessories for i550; connection to 120 V mains and 230 V mains

Inverter	Rated power	Mains voltage range	Brake resistor		
	[kW]		[V]	Order codes	Dimensions (h x w x d)
					
			Order codes	Dimensions (h x w x d)	
				[mm]	
i550-C0.25/120-1	0.25	1/N/PE AC 90 V ... 132 V 45 Hz ... 65 Hz	ERBM180R050W	175 x 21 x 40	
i550-C0.37/120-1	0.37		ERBM180R050W	175 x 21 x 40	
i550-C0.75/120-1	0.75		ERBP047R200W	320 x 41 x 122	
i550-C1.1/120-1	1.1		ERBP047R200W	320 x 41 x 122	
i550-C0.25/230-1	0.25	1/N/PE AC 170 V ... 264 V 45 Hz ... 65 Hz	ERBM180R050W	175 x 21 x 40	
i550-C0.37/230-1	0.37		ERBM180R050W	175 x 21 x 40	
i550-C0.55/230-1	0.55		ERBM100R100W	240 x 80 x 95	
i550-C0.75/230-1	0.75		ERBM100R100W	240 x 80 x 95	
i550-C1.1/230-1	1.1		ERBP033R200W	240 x 41 x 122	
i550-C1.5/230-1	1.5		ERBP033R200W	240 x 41 x 122	
i550-C2.2/230-1	2.2		ERBP033R200W	240 x 41 x 122	
i550-C0.25/230-2	0.25	1/N/PE AC or 3/PE AC 170 V ... 264 V 45 Hz ... 65 Hz	ERBM180R050W	175 x 21 x 40	
i550-C0.37/230-2	0.37		ERBM180R050W	175 x 21 x 40	
i550-C0.55/230-2	0.55		ERBM100R100W	240 x 80 x 95	
i550-C0.75/230-2	0.75		ERBM100R100W	240 x 80 x 95	
i550-C1.1/230-2	1.1		ERBP033R200W	240 x 41 x 122	
i550-C1.5/230-2	1.5		ERBP033R200W	240 x 41 x 122	
i550-C2.2/230-2	2.2		ERBP033R200W	240 x 41 x 122	
i550-C4.0/230-3	4	3/PE AC 170 V ... 264 V 45 Hz ... 65 Hz	ERBS015R800W	710 x 110 x 105	
i550-C5.5/230-3	5.5		ERBS015R800W	710 x 110 x 105	

There are also additional accessory components available for the i550 inverter. You can find the complete range in the configuration document for the i550.

	Mains choke		RFI filter			
			Short Distance		Long Distance	
	<ul style="list-style-type: none"> Optional up to 18.5 kW; mandatory from 22 kW upwards Reduction of the effective mains current Fewer current harmonics 		<ul style="list-style-type: none"> C1 up to 25 m (≤ 0.37 kW up to max. 15 m) C2 up to 50 m (≤ 0.37 kW up to max. 15 m) Operation with 30 mA residual-current circuit breaker 		<ul style="list-style-type: none"> C1 up to 50 m (≤ 0.37 kW up to max. 15 m) C2 up to 100 m (≤ 0.37 kW up to max. 15 m); ≤ 2.2 kW up to max. 50 m) Operation with 300 mA residual-current circuit breaker 	
	Order codes	Dimensions (h x w x d)	Order codes	Dimensions (h x w x d)	Order codes	Dimensions (h x w x d)
		[mm]		[mm]		[mm]
	ELN1-0500H009	75 x 66 x 82	–	–	–	–
	ELN1-0500H009	75 x 66 x 82	–	–	–	–
	ELN1-0250H018	96 x 96 x 90	–	–	–	–
	ELN1-0250H018	96 x 96 x 90	–	–	–	–
	ELN1-0900H005	75 x 66 x 82	IOFAE175B100S0000S	276 x 60 x 50	IOFAE175B100D0000S	276 x 60 x 50
	ELN1-0900H005	75 x 66 x 82	IOFAE175B100S0000S	276 x 60 x 50	IOFAE175B100D0000S	276 x 60 x 50
	ELN1-0500H009	75 x 66 x 82	IOFAE175B100S0000S	276 x 60 x 50	IOFAE175B100D0000S	276 x 60 x 50
	ELN1-0500H009	75 x 66 x 82	IOFAE175B100S0000S	276 x 60 x 50	IOFAE175B100D0000S	276 x 60 x 50
	ELN1-0250H018	96 x 96 x 90	IOFAE222B100S0000S	346 x 60 x 50	IOFAE222B100D0000S	346 x 60 x 50
	ELN1-0250H018	96 x 96 x 90	IOFAE222B100S0000S	346 x 60 x 50	IOFAE222B100D0000S	346 x 60 x 50
	ELN1-0250H018	96 x 96 x 90	IOFAE222B100S0000S	346 x 60 x 50	IOFAE222B100D0000S	346 x 60 x 50
	EZAELN3002B153	56 x 77 x 100	–	–	–	–
	EZAELN3004B742	60 x 95 x 115	–	–	–	–
	EZAELN3004B742	60 x 95 x 115	–	–	–	–
	EZAELN3006B492	69 x 95 x 120	–	–	–	–
	EZAELN3006B492	69 x 95 x 120	–	–	–	–
	EZAELN3008B372	85 x 120 x 140	–	–	–	–
	EZAELN3010B292	85 x 120 x 140	–	–	–	–
	EZAELN3016B182	95 x 120 x 140	–	–	–	–
	EZAELN3025B122	110 x 155 x 170	–	–	–	–

Accessories

Accessories for i550; connection to 400 V mains

Inverter	Rated power [kW]	Mains voltage range [V]	Brake resistor	
				
			Order codes	Dimensions (h x w x d) [mm]
	Heavy Duty			
i550-C0.37/400-3	0.37	3/PE AC 340 V ... 528 V 45 Hz ... 65 Hz	ERBM390R100W	235 x 21 x 40
i550-C0.55/400-3	0.55		ERBM390R100W	235 x 21 x 40
i550-C0.75/400-3	0.75		ERBM390R100W	235 x 21 x 40
i550-C1.1/400-3	1.1		ERBP180R200W	240 x 41 x 122
i550-C1.5/400-3	1.5		ERBP180R200W	240 x 41 x 122
i550-C2.2/400-3	2.2		ERBP180R200W	240 x 41 x 122
i550-C3.0/400-3	3		ERBP082R200W	320 x 41 x 122
i550-C4.0/400-3	4		ERBP047R200W	320 x 41 x 122
i550-C5.5/400-3	5.5		ERBP047R200W	320 x 41 x 122
i550-C7.5/400-3	7.5		ERBP027R200W	320 x 41 x 122
i550-C11/400-3	11		ERBP027R200W	320 x 41 x 122
i550-C15/400-3	15		ERBS018R800W	710 x 110 x 105
i550-C18/400-3	18.5		ERBS015R800W	710 x 110 x 105
i550-C22/400-3	22		ERBS015R800W	710 x 110 x 105
i550-C30/400-3	30		ERBG075D01K9	486 x 236 x 302
i550-C37/400-3	37		ERBG075D01K9	486 x 236 x 302
i550-C45/400-3	45		ERBG075D01K9	486 x 236 x 302
i550-C55/400-3	55		ERBG005R02K6	486 x 326 x 302
i550-C75/400-3	75		ERBG005R02K6	486 x 326 x 302
i550-C90/400-3	90		ERBG028D04K1	486 x 426 x 302
i550-C110/400-3	110	ERBG028D04K1	486 x 426 x 302	
	Light Duty			
i550-C3.0/400-3	4	3/PE AC 340 V ... 528 V 45 Hz ... 65 Hz	ERBP082R200W	320 x 41 x 122
i550-C4.0/400-3	5.5		ERBP047R200W	320 x 41 x 122
i550-C5.5/400-3	7.5		ERBP047R200W	320 x 41 x 122
i550-C7.5/400-3	11		ERBP027R200W	320 x 41 x 122
i550-C11/400-3	15		ERBP027R200W	320 x 41 x 122
i550-C15/400-3	18.5		ERBS018R800W	710 x 110 x 105
i550-C18/400-3	22		ERBS015R800W	710 x 110 x 105
i550-C22/400-3	30		ERBS015R800W	710 x 110 x 105
i550-C30/400-3	37		ERBG075D01K9	486 x 236 x 302
i550-C37/400-3	45		ERBG075D01K9	486 x 236 x 302
i550-C45/400-3	55		ERBG075D01K9	486 x 236 x 302
i550-C55/400-3	75		ERBG005R02K6	486 x 326 x 302
i550-C75/400-3	90		ERBG005R02K6	486 x 326 x 302
i550-C90/400-3	110		ERBG028D04K1	486 x 426 x 302
i550-C110/400-3	132		ERBG028D04K1	486 x 426 x 302

There are also additional accessory components available for the i550 inverter. You can find the complete range in the configuration document for the i550.

	Mains choke		RFI filter			
			Short Distance		Long Distance	
	<ul style="list-style-type: none"> • Heavy Duty: optional up to 18.5 kW, mandatory from 22 kW upwards • Light Duty: always mandatory • Reduction of the effective mains current • Fewer current harmonics 		<ul style="list-style-type: none"> • C1 up to 25 m (≤ 0.37 kW up to max. 15 m) • C2 up to 50 m (≤ 0.37 kW up to max. 15 m) • Operation with 30 mA residual-current circuit breaker 		<ul style="list-style-type: none"> • C1 up to 50 m (≤ 0.37 kW up to max. 15 m) • C2 up to 100 m (≤ 0.37 kW up to max. 15 m); ≤ 2.2 kW up to max. 50 m) • Mains filter from 22 kW (mains choke and Long Distance filter) integrated. • Operation with 300 mA residual-current circuit breaker 	
	Order codes	Dimensions (h x w x d)	Order codes	Dimensions (h x w x d)	Order codes	Dimensions (h x w x d)
		[mm]		[mm]		[mm]
	EZAELN3002B203	56 x 77 x 100	IOFAE175F100S0000S	276 x 60 x 50	IOFAE175F100D0000S	276 x 60 x 50
	EZAELN3002B153	56 x 77 x 100	IOFAE175F100S0000S	276 x 60 x 50	IOFAE175F100D0000S	276 x 60 x 50
	EZAELN3004B742	60 x 95 x 115	IOFAE175F100S0000S	276 x 60 x 50	IOFAE175F100D0000S	276 x 60 x 50
	EZAELN3004B742	60 x 95 x 115	IOFAE222F100S0000S	346 x 60 x 50	IOFAE222F100D0000S	346 x 60 x 50
	EZAELN3004B742	60 x 95 x 115	IOFAE222F100S0000S	346 x 60 x 50	IOFAE222F100D0000S	346 x 60 x 50
	EZAELN3006B492	69 x 95 x 120	IOFAE222F100S0000S	346 x 60 x 50	IOFAE222F100D0000S	346 x 60 x 50
	EZAELN3008B372	85 x 120 x 140	IOFAE255F100S0001S	346 x 90 x 60	IOFAE240F100D0000S	346 x 60 x 50
	EZAELN3010B292	85 x 120 x 140	IOFAE255F100S0001S	346 x 90 x 60	IOFAE240F100D0000S	346 x 60 x 50
	EZAELN3016B182	95 x 120 x 140	IOFAE255F100S0001S	346 x 90 x 60	IOFAE255F100D0001S	346 x 90 x 60
	EZAELN3016B182	95 x 120 x 140	IOFAE311F100S0000S	371 x 120 x 60	IOFAE311F100D0000S	371 x 120 x 60
	EZAELN3025B122	110 x 155 x 170	IOFAE311F100S0000S	371 x 120 x 60	IOFAE311F100D0000S	371 x 120 x 60
	EZAELN3030B981	110 x 155 x 170	–	–	IOFAE318F100D0000S	436 x 205 x 90
	EZAELN3040B741	112 x 185 x 200	–	–	IOFAE318F100D0000S	436 x 205 x 90
	EZAELN3045B651	112 x 185 x 200	–	–	IOFAE322F100D0000S	436 x 205 x 90
	EZAELN3063B471	122 x 185 x 210	–	–	IOFAE330F100D0000S	590 x 250 x 105
	EZAELN3080B371	125 x 210 x 240	–	–	IOFAE337F100D0000S	590 x 250 x 105
	EZAELN3080B371	125 x 210 x 240	–	–	IOFAE345F100D0001S	590 x 250 x 105
	EZAELN3100B301	139 x 267 x 205	–	–	IOFAE355F100D0001S	700 x 250 x 105
	EZAELN3160B191	149 x 291 x 215	–	–	IOFAE375F100D0001S	700 x 250 x 105
	EZAELN3180B171	164 x 316 x 235	–	–	IOFAE411F100D0001S	855 x 250 x 130
	EZAELN3200B151	144 x 352 x 265	–	–	IOFAE411F100D0001S	855 x 250 x 130
	EZAELN3010B292	85 x 120 x 140	IOFAE255F100S0001S	346 x 90 x 60	IOFAE240F100D0000S	346 x 60 x 50
	EZAELN3016B182	95 x 120 x 140	IOFAE255F100S0001S	346 x 90 x 60	IOFAE255F100D0001S	346 x 90 x 60
	EZAELN3016B182	95 x 120 x 140	IOFAE255F100S0001S	346 x 90 x 60	IOFAE255F100D0001S	346 x 90 x 60
	EZAELN3025B122	110 x 155 x 170	IOFAE311F100S0000S	371 x 120 x 60	IOFAE311F100D0000S	371 x 120 x 60
	EZAELN3030B981	110 x 155 x 170	IOFAE311F100S0000S	371 x 120 x 60	IOFAE311F100D0000S	371 x 120 x 60
	EZAELN3040B741	112 x 185 x 200	–	–	IOFAE318F100D0000S	436 x 205 x 90
	EZAELN3045B651	112 x 185 x 200	–	–	IOFAE322F100D0000S	436 x 205 x 90
	EZAELN3063B471	122 x 185 x 210	–	–	IOFAE322F100D0000S	436 x 205 x 90
	EZAELN3080B371	125 x 210 x 240	–	–	IOFAE337F100D0000S	590 x 250 x 105
	EZAELN3090B331	115 x 267 x 205	–	–	IOFAE345F100D0001S	590 x 250 x 105
	EZAELN3100B301	139 x 267 x 205	–	–	IOFAE345F100D0001S	590 x 250 x 105
	EZAELN3125B241	139 x 291 x 215	–	–	IOFAE355F100D0001S	700 x 250 x 105
	EZAELN3160B191	149 x 291 x 215	–	–	IOFAE375F100D0001S	700 x 250 x 105
	EZAELN3200B151	144 x 352 x 265	–	–	IOFAE411F100D0001S	855 x 250 x 130
	EZAELN3250B121	207 x 352 x 260	–	–	IOFAE411F100D0001S	855 x 250 x 130

Lenze Drives GmbH
Postfach 10 13 52
D-31763 Hamelin
Germany
Phone +49 5154 82-0
Fax +49 5154 82-2800
Mail Lenze@Lenze.com
Web www.Lenze.com

Lenze Service GmbH
Breslauer Straße 3
D-32699 Extertal
Germany
Phone +49 80002446877 (24 h helpline)
Fax +49 5154 82-1396
Mail service.de@Lenze.com