

Rotary blade level indicators

Level limit switches for bulk goods

DF

Dust



Explosion protection information

and supplement to the operating instructions

Index	Page
Marking	02
Details on type plate	03
Equipment category appropriation by zones	04
Ambient temperature	06
maximum surface temperature	07
Pressure, vacuum	08
Special conditions and instructions	10

Marking in accordance with ATEX and DIN EN IEC 60079-0

Rotary blade level indicator as electrical device for use in zone 20.

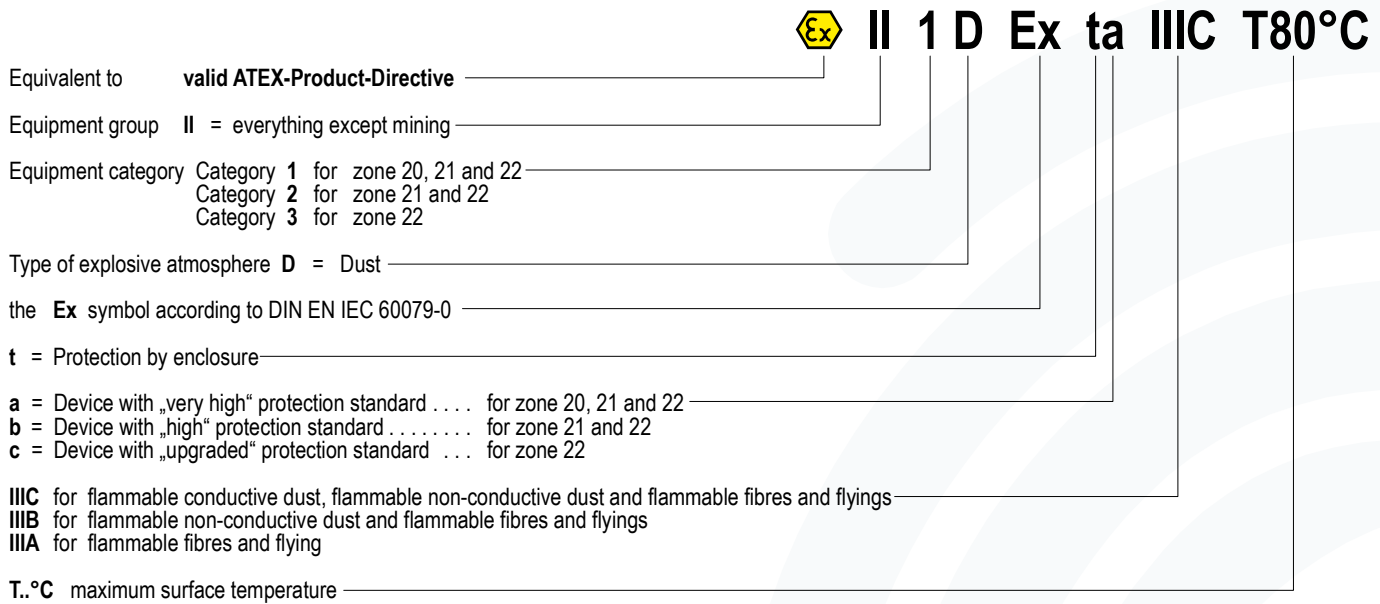

Rotary blade level indicators as electrical device for use on the boundary from zone 20 to zone 21.



Pressure decoupling bell housing as non-electrical device for use on the boundary from zone 20 to non-hazardous area.
for the installation of level indicator without ATEX certificate

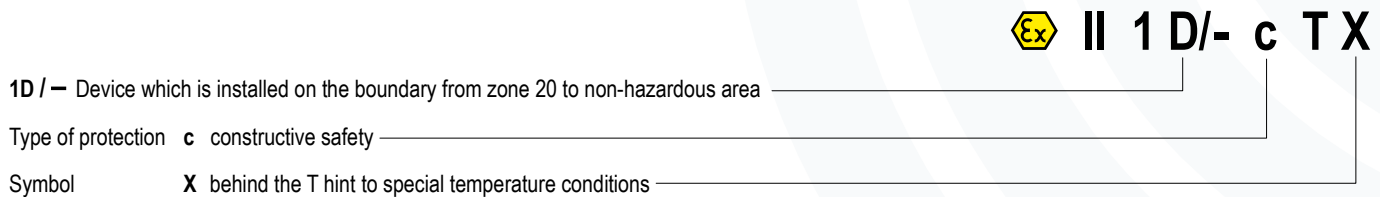

Type plate details **Dust**

Rotary blade level indicator as electrical device for use on the boundary from zone 20 to zone 21.

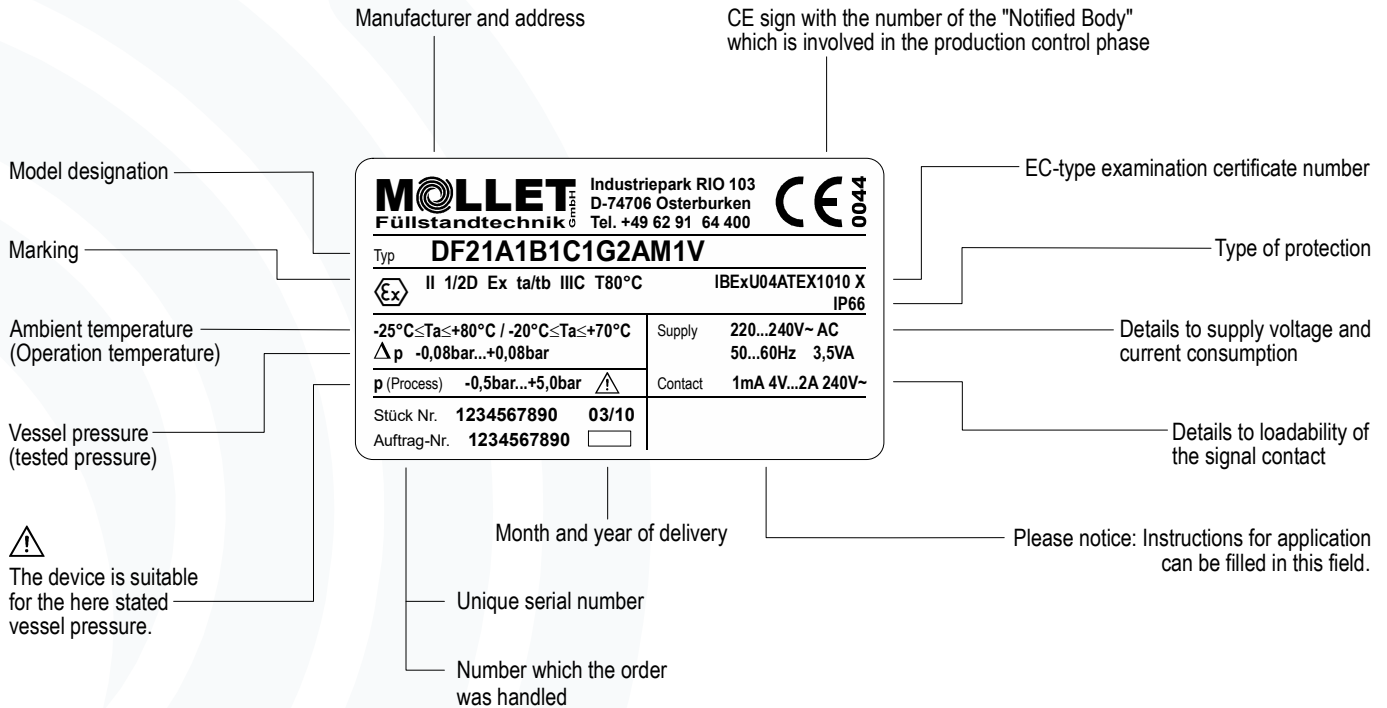

Pressure decoupling bell housing as non electrical device for use on the boundary from zone 20 to non-hazardous area.
for the installation on level indicators without ATEX certificate.

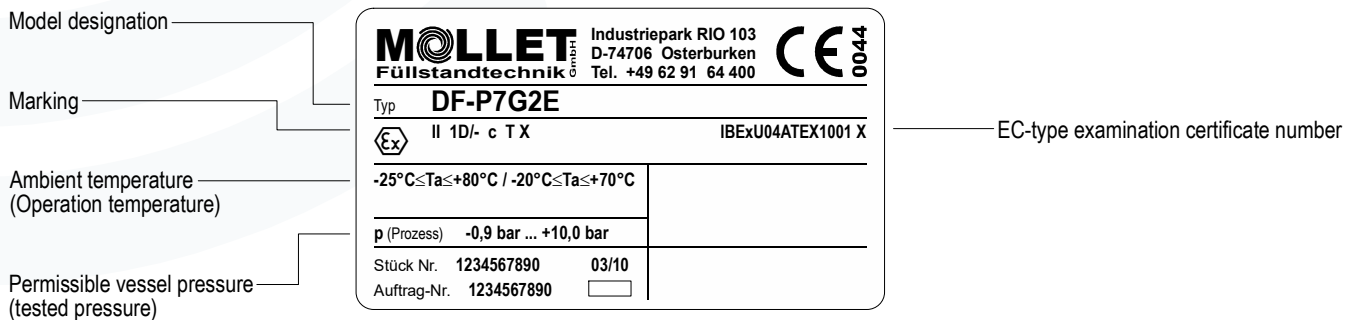

Note: The X behind the certification number indicates special conditions for the safe application of the equipment in the appendix to the EC-type examination certificate

Equipment category appropriation by zones

Installation on the boundary from zone 20 to zone 21 just as from zone 21 to Zone 22 resp. non-hazardous area.

The B1 variant is the most used and versatile version and can be used in almost all cases.

Special conditions:

The "X" behind the number of the EC-type-examination certificate means that the device can be installed in the walls of silos, vessels, machines, filters etc. when the inside is classified as zone 20.



Order code **A1B1** or **A2B1**

Marking:

II 1 / 2 D

Category 1 / Category 2

Dust 

MOLLET Industriepark RIO 103 Füllstandtechnik GmbH D-74706 Osterburken Tel. +49 62 91 64 400		 0044
Typ DF23A1 B1 C1G4AM1V		
 II 1/2D Ex ta/tb IIIC T80°C I BExU04ATEX1010 X IP66		
-25°C ≤ Ta ≤ +80°C / -20°C ≤ Ta ≤ +70°C	Supply	220...240V~ AC
Δp -0,08bar...+0,08bar		50...60Hz 3,5VA
p (Process) -0,5bar...+5,0bar 	Kontakt	1mA 4V...2A 240V~
Stück Nr. 1234567890 03/10		
Auftrag-Nr. 1234567890 <input type="text"/>		

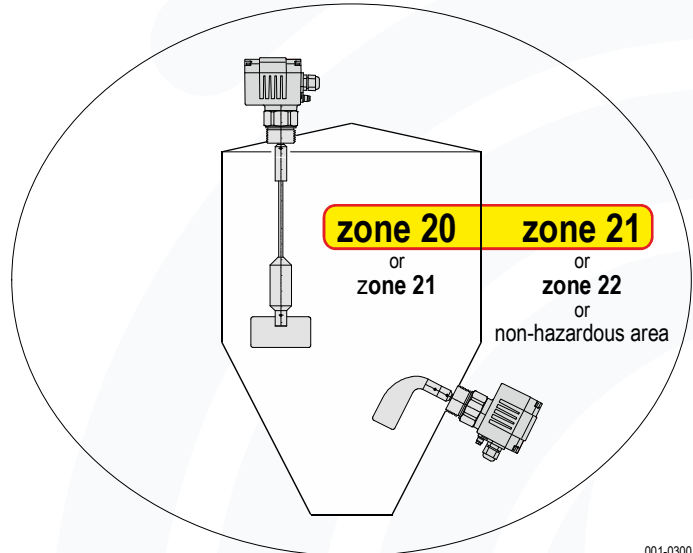

001-0300

Installation on the boundary from zone 20 to zone 22.

The version B3 is, as well as version B1, especially versatile and therefore can also be used in many cases.

Special conditions:

The "X" behind the number of the EC-type-examination certificate means that the device can be installed in the walls of silos, vessels, machines, filters etc. when the inside is classified as zone 20.



Order code **A1B3** or **A2B3**

Marking:

II 1 / 3 D

Category 1 / Category 3

Dust 

MOLLET Industriepark RIO 103 Füllstandtechnik GmbH D-74706 Osterburken Tel. +49 62 91 64 400		 0044
Typ DF21A1 B3 C1G2AM1V		
 II 1/3D Ex ta/tc IIIB T80°C ATEX-PP-04-970 X IP66		
-25°C ≤ Ta ≤ +80°C / -20°C ≤ Ta ≤ +70°C	Supply	220...240V~ AC
Δp -0,08bar...+0,08bar		50...60Hz 3,5VA
p (Process) -0,5bar...+5,0bar 	Contact	1mA 4V...2A 240V~
Stück Nr. 1234567890 03/10		
Auftrag-Nr. 1234567890 <input type="text"/>		

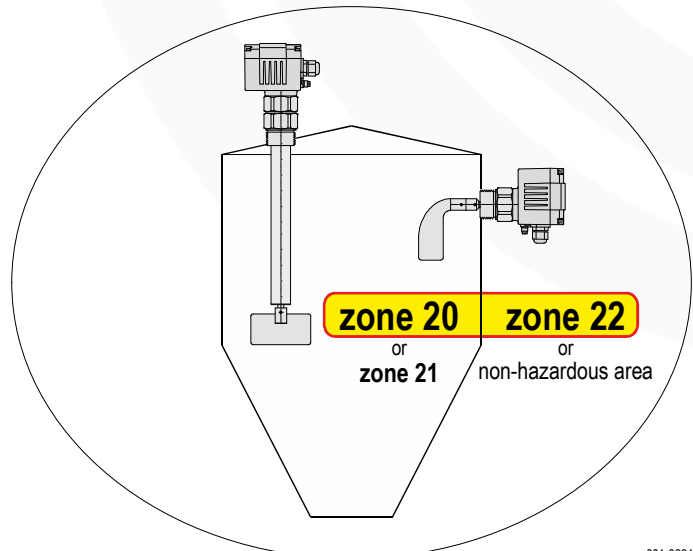

001-0301

Equipment category appropriation by zones

Complete installation in vessels with zone 20 inside.

B2 version for special cases of application where the level indicators including the control head has to be installed completely within zone 20.

ATTENTION:



The design of the equipment version **B2** allows a complete cover of the entire level indicator by bulk goods.

Order code **A1B2** or **A2B2**

Marking:

II 1 D
Category 1

Dust 

MOLLET Füllstandtechnik GmbH		Industriepark RIO 103 D-74706 Osterburken Tel. +49 62 91 64 400	 0044
Typ DF21A1 B2 C1D2G2AM1V			
 II 1D Ex ta IIIC T70°C		IBExU04ATEX1034X IP66	
-25°C ≤ Ta ≤ +45°C	Supply	220...240V~ AC	
Δ p -0,08bar...+0,08bar		50...60Hz 3,5VA	
p (Process) -0,5bar...+5,0bar 	Contact	1mA 4V...2A 240V~	
Stück Nr. 1234567890 03/10			
Auftrag-Nr. 1234567890 <input type="checkbox"/>			

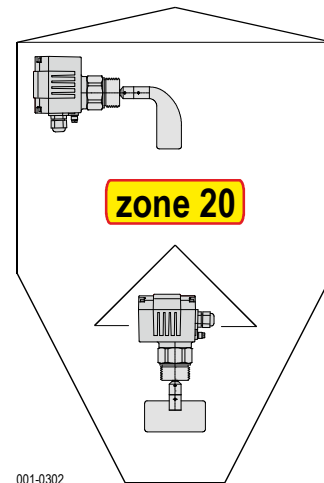

001-0302

Ambient temperatures Ta Inside process temperature, outside ambient temperature.

The ambient temperature T_a defines the maximum operating temperature of the indicators.
Inside the vessel this is process temperature (the air or the bulk goods temperature) nearby the device.

MOLLET Füllstandtechnik GmbH		Industriepark RIO 103 D-74706 Osterburken Tel. +49 62 91 64 400	CE 0044
Typ DF21A1B1C1G2AM1V			
Ex II 1/2D Ex ta/tb IIIC T80°C		IBExU04ATEX1010 X IP66	
-25°C ≤ Ta ≤ +80°C / -20°C ≤ Ta ≤ +70°C		Supply	220...240V~ AC
Δp -0,08bar...+0,08bar			50...60Hz 3,5VA
p (Process) -0,5bar...+5,0bar		Contact	1mA 4V...2A 240V~
Stück Nr. 1234567890 03/10			
Auftrag-Nr. 1234567890			

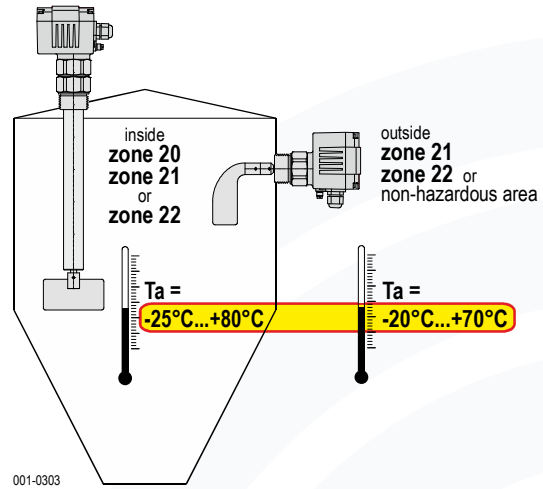

Ambient temperatures Ta Inside high process temperature, outside ambient temperature.

The ambient temperature T_a defines the maximum operating temperature of the indicators.
Inside the vessel this can be the ambient and/or the bulk goods temperature and therefore the process temperature.

The temperature decoupling bell housing works as a cooling lane.
A maximum of 80 °C are allowed to reach the control head.

MOLLET Füllstandtechnik GmbH		Industriepark RIO 103 D-74706 Osterburken Tel. +49 62 91 64 400	CE 0044
Typ DF21A1B1C1E1G2AM1V			
Ex II 1/2D Ex ta/tb IIIC T80°C		IBExU04ATEX1010 X IP66	
-40°C ≤ Ta ≤ +150°C / -20°C ≤ Ta ≤ +70°C		Supply	220...240V~ AC
Δp -0,08bar...+0,08bar			50...60Hz 3,5VA
p (Process) -0,5bar...+5,0bar		Contact	1mA 4V...2A 240V~
Stück Nr. 1234567890 03/10			
Auftrag-Nr. 1234567890			

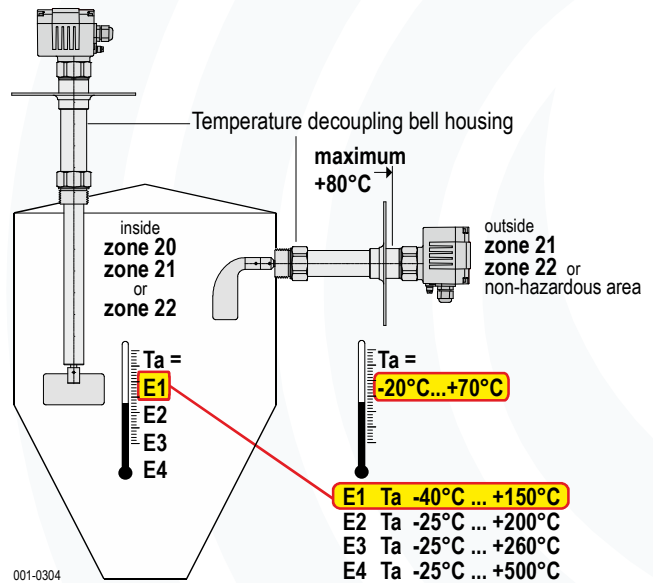

Ambient temperatures Ta If the indicator is completely installed in the vessel.

MOLLET Füllstandtechnik GmbH		Industriepark RIO 103 D-74706 Osterburken Tel. +49 62 91 64 400	CE 0044
Typ DF21A1B2C1D2G2EM1V			
Ex II 1D Ex ta IIIC T70°C		IBExU04ATEX1034 X IP66	
-20°C ≤ Ta ≤ +45°C		Supply	220...240V~ AC
Δp -0,08bar...+0,08bar			50...60Hz 3,5VA
		Contact	1mA 4V...2A 240V~
Stück Nr. 1234567890 03/10			
Auftrag-Nr. 1234567890			

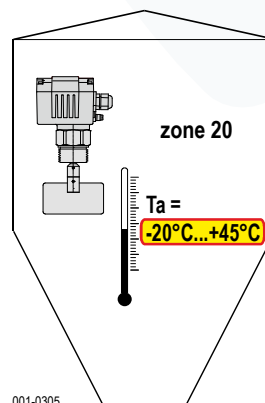

The ambient temperature T_a defines the maximum operating temperature of the indicators.
Inside the vessel this can be the ambient and/or the bulk goods temperature and therefore the process temperature.

maximum surface temperature T Inside process temperature, outside ambient temperature.

The maximum surface temperature means the hottest point that can occur at the equipment in the case of a fault.

MOLLET Füllstandtechnik GmbH Industriepark RIO 103 D-74706 Osterburken Tel. +49 62 91 64 400		
Typ DF21A1B1C1G2AM1V		
Ex II 1/2D Ex ta/tb IIIc T80°C IBEExU04ATEX1010 X IP66		
$-25^{\circ}\text{C} \leq T_a \leq \leq 80^{\circ}\text{C}$ / $-20^{\circ}\text{C} \leq T_a \leq +70^{\circ}\text{C}$	Supply	220...240V~ AC
Δp -0,08bar...+0,08bar		50...60Hz 3,5VA
p (Process) -0,5bar...+5,0bar	Contact	1mA 4V...2A 240V~
Stück Nr. 1234567890	03/10	
Auftrag-Nr. 1234567890		

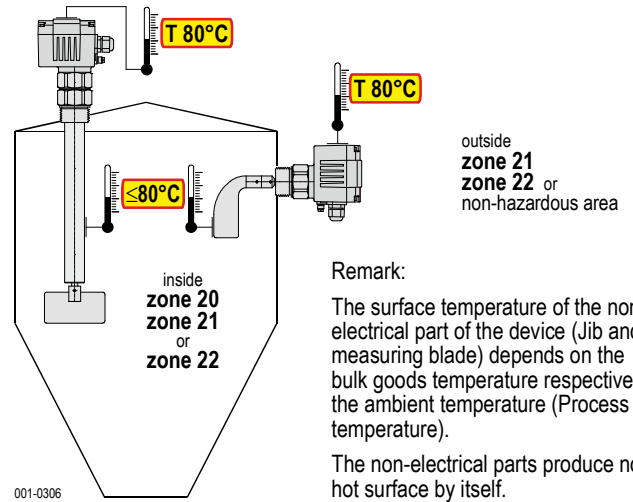

maximum surface temperature T Inside high process temperature, outside ambient temperature.

The **X** refers to hints in the EC-type-examination certificate:

The non-electrical part of the device (Jib, measuring blade and decoupling bell housing) produces no elevation of the temperature by itself, but can transfer high temperatures from inside the vessel. Because of this reason the surface temperature has to be defined according to the process temperature (Bulk goods temperature respectively the ambient temperature) from the interior of the vessel.

MOLLET Füllstandtechnik GmbH Industriepark RIO 103 D-74706 Osterburken Tel. +49 62 91 64 400		
Typ DF21A1B1C1E1G2AM1V		
Ex II 1/2D Ex ta/tb IIIc T80°C IBEExU04ATEX1010 X IP66		
$-25^{\circ}\text{C} \leq T_a \leq \leq 150^{\circ}\text{C}$ / $-20^{\circ}\text{C} \leq T_a \leq +70^{\circ}\text{C}$	Supply	220...240V~ AC
Δp -0,08bar...+0,08bar		50...60Hz 3,5VA
p (Process) -0,5bar...+5,0bar	Contact	1mA 4V...2A 240V~
Stück Nr. 1234567890	03/10	
Auftrag-Nr. 1234567890		

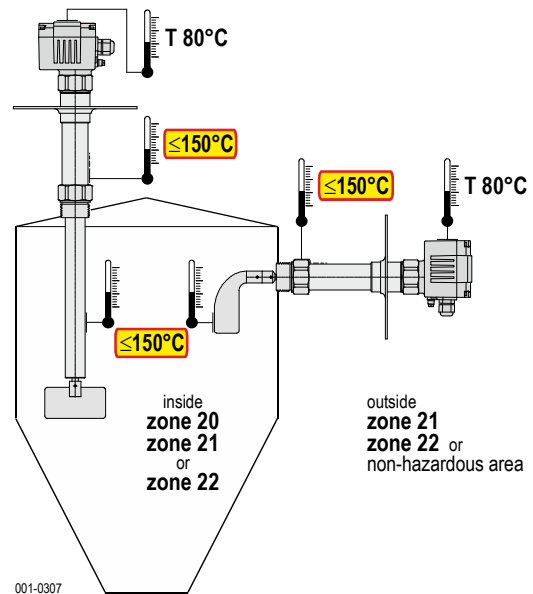

maximum surface temperature T If the indicator is completely installed in the vessel.

The maximum surface temperature means the hottest point that can occur at the equipment in the case of a fault.

MOLLET Füllstandtechnik GmbH Industriepark RIO 103 D-74706 Osterburken Tel. +49 62 91 64 400		
Typ DF21A1B2C1D1G2EM1V		
Ex II 1D Ex ta IIIc T70°C IBEExU04ATEX1034 X IP66		
$-20^{\circ}\text{C} \leq T_a \leq \leq 45^{\circ}\text{C}$	Supply	220...240V~ AC
Δp -0,08bar...+0,08bar		50...60Hz 3,5VA
	Contact	1mA 4V...2A 240V~
Stück Nr. 1234567890	03/10	
Auftrag-Nr. 1234567890		

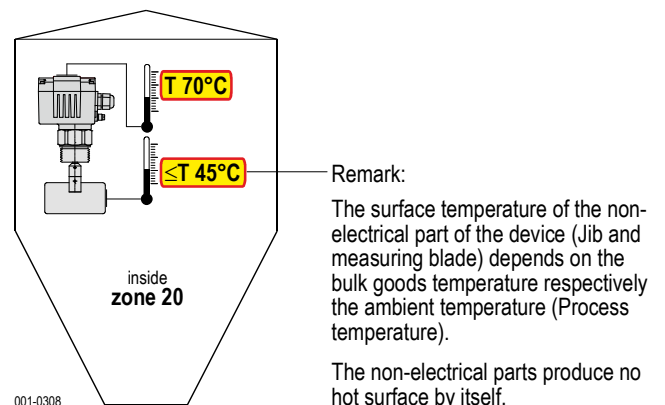

Pressure, vacuum Δp , p (Process)

High and low pressures in the case of deviations as well as in atmospheric and in non-atmospheric conditions.

The regulations, legislation and ordinances must be strictly observed when using rotary blade level indicators in vessels with high and low pressures.

MOLLET Industriepark RIO 103 Füllstandtechnik GmbH D-74706 Osterburken Tel. +49 62 91 64 400		0044
Typ DF21A1B1C1 P1 G2AM1V		
II 1/2D Ex ta/tb IIIC T80°C IBE <u>X</u> U04ATEX1010 IP66		
$-25^{\circ}\text{C} \leq T_a \leq +80^{\circ}\text{C} / -20^{\circ}\text{C} \leq T_a \leq +70^{\circ}\text{C}$		Supply 220...240V~ AC 50...60Hz 3,5VA
Δp -0,08bar...+0,08bar	Kontakt 1mA 4V...2A 240V~	
p (Process) -0,5bar...+10,0bar	Stück Nr. 1234567890 03/10 Auftrag-Nr. 1234567890	

The **X** refers to hints in the EC-type-examination certificate:

The device can be installed in the walls of vessels with deviating atmospheric conditions with a difference in pressure up to 80 mbar at the shaft passage.

Please note!

The design of the devices is suitable for vessel pressures:

- 0,5 bar... 5 bar in the version **P0 (Standard)**
- 0,5 bar...10 bar in the version **P1**
- 0,9 bar...10 bar in the version **P6**

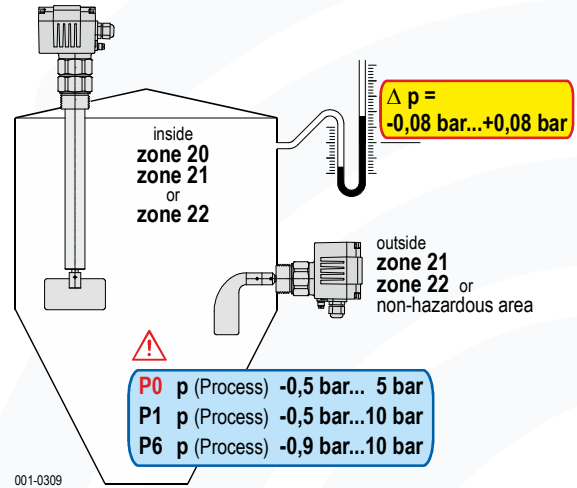

These pressures are outside the atmospheric conditions defined by the directive 94/9/EG.

For pressure with the device models **P0**, **P1** and **P6** the EC-type-examination certificates are not valid. These devices are under the responsibility of the user (Please consider: There maybe national laws and regulations).

Pressure, vacuum p (Process) If inside the vessel is zone 20 or zone 21.

Pressure decoupling bell housing P7

Pressure decoupling bell housings has to be used by vessel pressures above 0.08 bar.

The pressure decoupling bell housing **P7** is type examined and certificated for the use in explosive hazardous areas with pressures from -0.9 bar up to 10 bar.

MOLLET Industriepark RIO 103 Füllstandtechnik GmbH D-74706 Osterburken Tel. +49 62 91 64 400		0044
Typ DF21A1B1C1 P7 G2AM1V		
II 1/2D Ex ta/tb IIIC T80°C IBE <u>X</u> U04ATEX1010 X IP66		
$-25^{\circ}\text{C} \leq T_a \leq +80^{\circ}\text{C} / -20^{\circ}\text{C} \leq T_a \leq +70^{\circ}\text{C}$		Supply 220...240V~ AC 50...60Hz 3,5VA
p (Process) -0,9bar...+10,0bar	Kontakt 1mA 4V...2A 240V~	
Stück Nr. 1234567890 03/10 Auftrag-Nr. 1234567890		

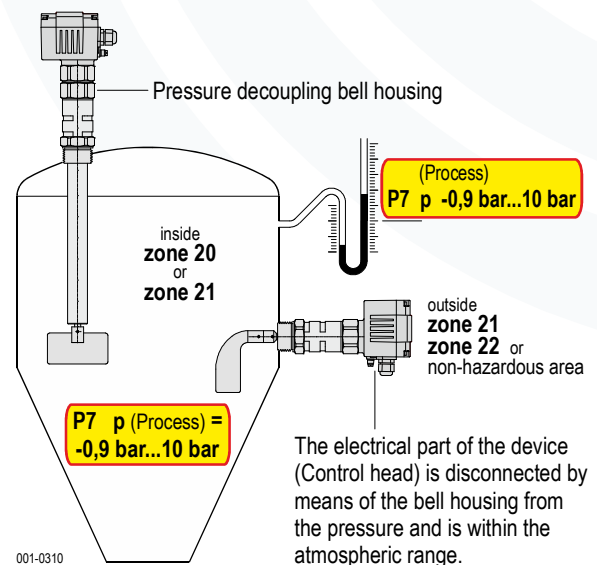

Pressure, vacuum Δp , p (Process) If the indicator is completely installed in the vessel.

High and low pressure in the case of installation in the vessel.

If the device is completely installed inside the vessel, the high and low pressure must not exceed 80 mbar.

MOLLET Industriepark RIO 103 Füllstandtechnik GmbH D-74706 Osterburken Tel. +49 62 91 64 400		
Typ DF21A1 B2 C1D2G2EM1V		
Ex II 1D Ex ta IIIC T80°C IBEU04ATEX1034 X IP66		
$-20^{\circ}\text{C} \leq T_a \leq +45^{\circ}\text{C}$ Δp -0,08bar...+0,08bar		Supply 220...240V~ AC 50...60Hz 3,5VA Kontakt 1mA 4V...2A 240V~
Stück Nr. 1234567890 03/10 Auftrag-Nr. 1234567890		

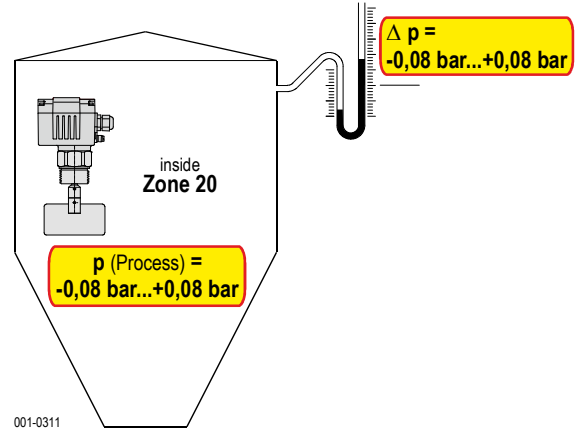

Pressure, vacuum p (Process) Inside the vessel zone 20 or zone 21, outside non-hazardous area.

Pressure decoupling bell housing DF-P7.

The explosive hazardous area and the vessel pressure are separated from the non-hazardous area outside by the type-examined bell housing.

Within the non-hazardous area outside the vessel the control head can be used without ATEX certificate.

MOLLET Industriepark RIO 103 Füllstandtechnik GmbH D-74706 Osterburken Tel. +49 62 91 64 400		
Typ DF-P7 G2E		
Ex II 1D/- c T X IBEU 04 ATEX 1001 X		
$-25^{\circ}\text{C} \leq T_a \leq +80^{\circ}\text{C} / -$ p (Process) -0,9bar...+10,0bar		
Stück Nr. 1234567890 03/10 Auftrag-Nr. 1234567890		

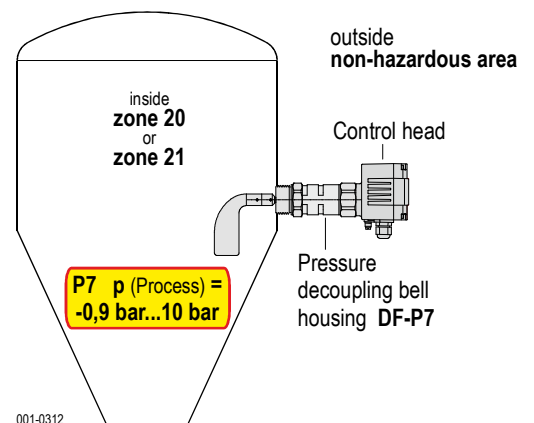



1. Special conditions and instructions for safe application

- 1.1 The installation, maintenance, initial operation, removal and repair have to be controlled resp. checked by an "authorized person" for explosion protection.
- 1.2 Take notice of the requirements of DIN EN 60079-14, DIN EN 60079-17 and DIN EN 1127-1, especially regarding the dust deposits and temperatures and follow the pertinent rules and regulations.
- 1.3 As soon as the device will be brought into the explosion hazardous area it has to be mounted immediately at the pre-caused place and a cable has to be brought into the cable gland.
- 1.4 Using the device in ambient temperatures $> +60\text{ °C}$, the applied connection cables have to be made for temperatures of min. $+80\text{ °C}$.
- 1.5 To secure the type of protection, the screw nut of the cable gland has to be fixed at the installation with a torsional force of min. 5.0 Nm.
ATTENTION! If it will be fastened too strong, the IP-protection can be affected.
- 1.6 Take notice of the specifications on the data plate.
- 1.7 The earth connection of the device has to be installed in such a way that mechanical damage will be excluded.
- 1.8 The level indicators may only be supplemented by such non-electrical components (Jib and measuring blade) which are in accordance with the demands of the directive 94/9/EC.
- 1.9 The maximum difference in pressure at the shaft passage must not exceed 80 mbar and the working temperature on the shaft seal must not exceed $+80\text{ °C}$, when installing level indicators in the silo wall under deviating atmospheric conditions.
- 1.10 The process connection, jib and measuring blade must be made of stainless steel in the case of combustible dusts with a minimum ignition energy under 3 mJ or a minimum ignition temperature under $+300\text{ °C}$ (BAM assessment).
- 1.11 The plastic measuring blade TK 150 must not be installed, should the container be filled by a pneumatic conveying system.



II 1D

2. Additional special conditions and instructions for safe application for the versions DF..A1B2 and DF..A2B2

- 2.1 It must be ensured that the measuring blade is always covered with material before control head housing by selecting an appropriate installation position.
- 2.2 If the level indicator DF is completely installed within the zone 20 and combustible dust with a minimum ignition energy under 3 mJ or a minimum ignition temperature under $+300\text{ °C}$ (BAM assessment) exists, then the control head housing must be made of stainless steel.
- 2.3 By means of an appropriate circuit it must be ensured that the level indicator is completely disconnected from the main power supply when the temperature cut-out responds and an automatic restart is prevented.